

SiC Schottky Barrier Rectifier
Reverse Voltage - 650V
Forward Current - 15A

Features

- ◆ Reverse withstand voltage 650V
- ◆ Zero reverse recovery current
- ◆ High working frequency
- ◆ Switch characteristics are not affected by temperature
- ◆ Fast switching speed
- ◆ Positive temperature coefficient of positive pressure drop

Advantages

- ◆ Very low switching loss
- ◆ Higher efficiency
- ◆ Low dependence of the system on the heat sink
- ◆ No thermal collapse in parallel devices

Application

- ◆ Switching mode power supply, AC/DC converter
- ◆ Power factor correction
- ◆ Motor drive
- ◆ PV inverter and wind turbine

Absolute Maximum Rating (Ta=25°C)

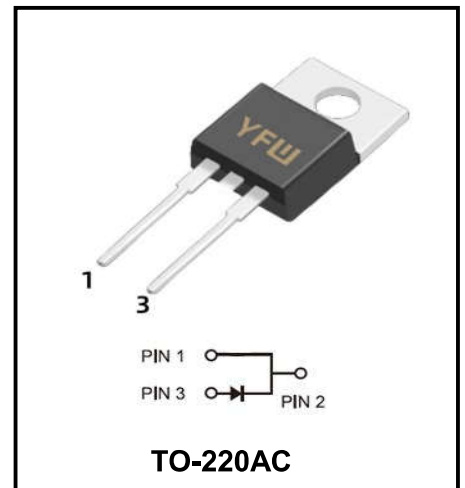

Parameter	Symbol	Test conditions	Value	Unit
Peak repetitive reverse voltage	V_{RRM}		650	V
Working Peak Reverse voltage	V_{RWM}		650	V
DC Blocking Voltage	V_{DC}		650	V
Average rectified output current	$I_{F(AV)}$	Ta=25°C	38	A
		Ta=125°C	18	
		Ta=150°C	15	
Forward repetitive peak current	I_{FRM}	T _C =25°C, tp=10ms, Half Sine Wave	65	A
		T _C =110°C, tp=10ms, Half Sine Wave	45	
Forward surge current	I_{FSM}	T _C =25°C, tp=10ms, Half Sine Wave	155	A
		T _C =110°C, tp=10ms, Half Sine Wave	145	
Power dissipation	P_{tot}	Ta=25°C	120	W
		Ta=110°C	55	
Junction temperature	T _j		-55 ~ +175	°C
Storage temperature	T _{stg}		-55 ~ +175	°C
Mounting Torque		M3 Screw	1	Nm
		6-32 Screw	8.8	

Thermal characteristics

Parameter	Symbol	Value	Unit
Thermal Resistance - Junction to Case	$R_{\theta JC}$	1	$^{\circ}\text{C}/\text{W}$

Electrical Characteristics (Ta=25°C unless otherwise specified)

Parameter	Symbol	Test conditions	Min	Typ	Max	Unit
Forward voltage	V_F	$I_F = 20\text{ A}, T_j = 25^{\circ}\text{C}$ $I_F = 20\text{ A}, T_j = 175^{\circ}\text{C}$		1.5 2.0	1.8 2.4	V
Reverse current	I_R	$V_R = 650\text{V}, T_j = 25^{\circ}\text{C}$ $V_R = 650\text{V}, T_j = 175^{\circ}\text{C}$			60 220	μA
Total capacitive charge	Q_C	$V_R = 400\text{V}, I_F = 10\text{A}$ $di/dt = 500\text{A}/\mu\text{s}, T_j = 25^{\circ}\text{C}$		45		nC
Total capacitance	C	$V_R = 0\text{V}, T_j = 25^{\circ}\text{C}, f = 1\text{MHz}$ $V_R = 200\text{V}, T_j = 25^{\circ}\text{C}, f = 1\text{MHz}$ $V_R = 400\text{V}, T_j = 25^{\circ}\text{C}, f = 1\text{MHz}$		877 85 65		pF

Typical Characteristics

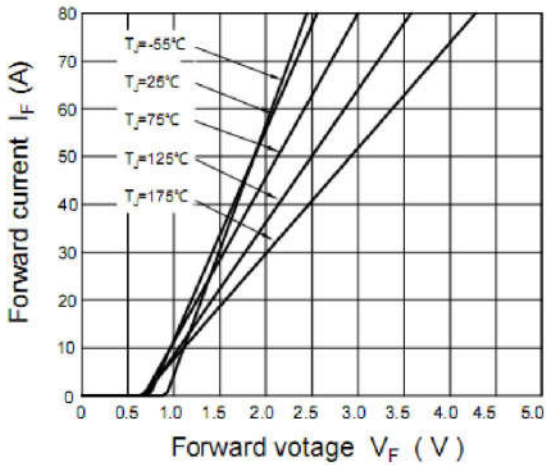

Figure 1. Forward Characteristics

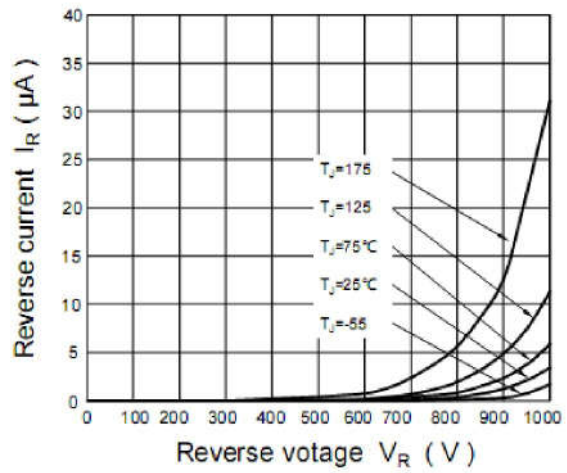

Figure 2. Reverse Characteristics

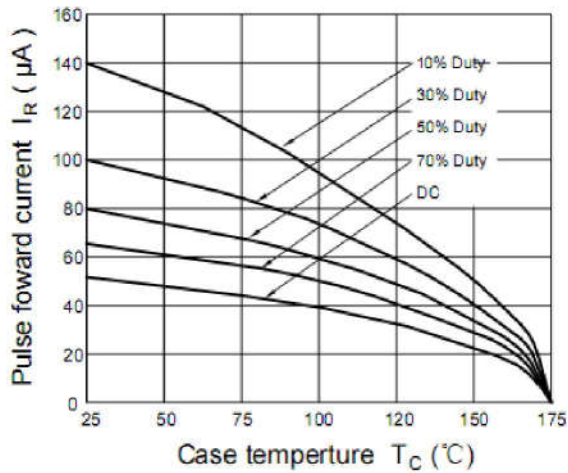

Figure 3. Current Derating

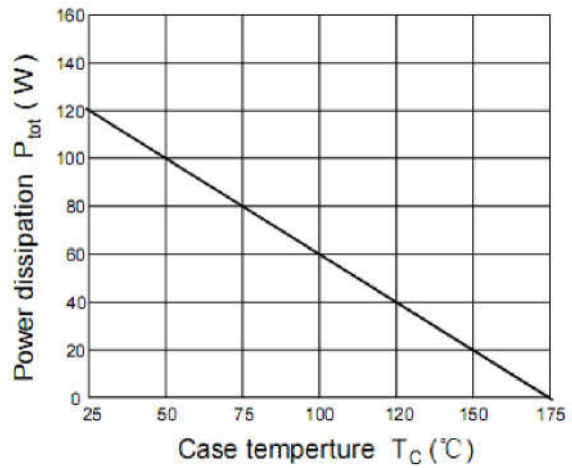

Figure 4. Power Derating

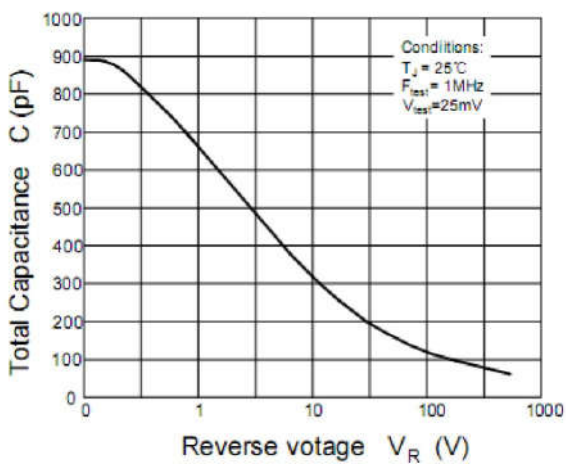

Figure 5. Capacitance vs reverse voltage

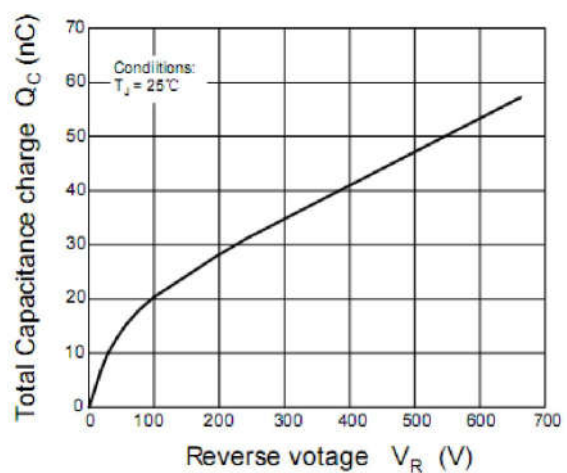
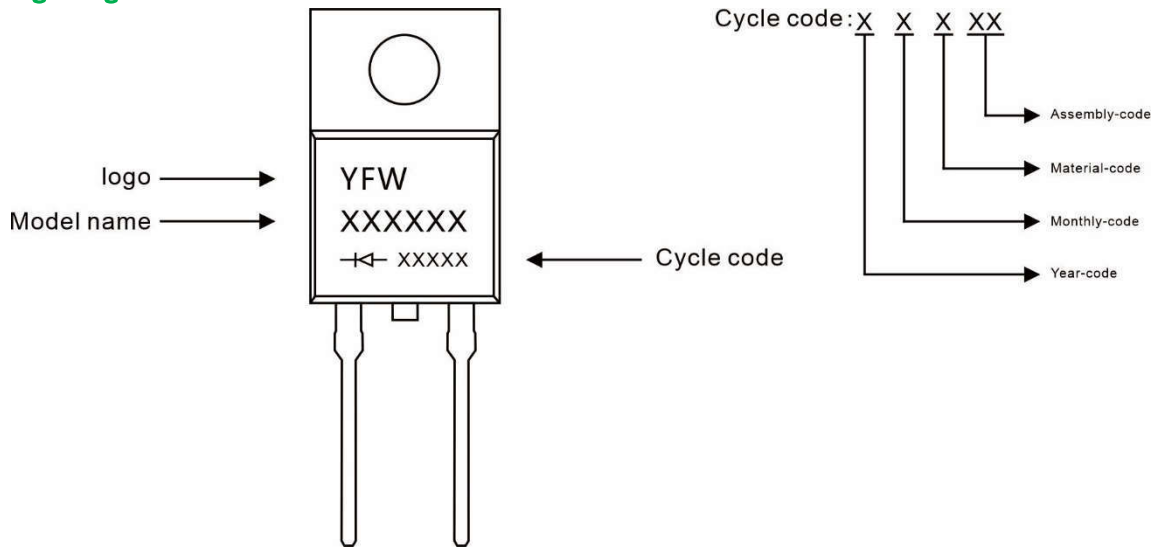

Figure 6. Total Capacitance charge vs. reverse voltage

Marking Diagram



Ordering information

Model name	Package	Unit Weight	Base Quantity	Packing Quantity
YFWD315065AC	TO-220AC	0.067oz(1.9g)	50pcs/tube	1000PCS/Box 5000PCS/Carton

Package Dimensions

TO-220AC

Symbol	Millimeter		Inches	
	Min.	Max.	Min.	Max.
A	10.15	10.35	0.400	0.407
B	2.65	2.95	0.104	0.116
C	3.70	3.90	0.146	0.154
D	28.5	29.5	1.12	1.16
E	1.3	1.45	0.051	0.057
F	0.8	1.1	0.031	0.043
G	2.9	3.3	0.114	0.130
H	15.0	16.0	0.591	0.630
I	0.38	0.42	0.015	0.017
J	4.45	4.55	0.175	0.179
K	1.25	1.35	0.049	0.053
L	6.35	6.55	0.250	0.258
M	Typ5.08		Typ0.2	
N	Typ2.54		Typ0.1	
O	0.76	0.84	0.030	0.033
P	3.1	3.3	0.122	0.130

Disclaimer

The information presented in this document is for reference only. GuangDong Youfeng Microelectronics Co.,Ltd. reserves the right to make changes without notice for the specification of the products displayed herein to improve reliability, function or design or otherwise. The product listed herein is designed to be used with ordinary electronic equipment or devices, and not designed to be used with equipment or devices which require high level of reliability and the malfunction of which would directly endanger human life (such as medical instruments, transportation equipment, aerospace machinery, nuclear-reactor controllers, fuel controllers and other safety devices), YFW or anyone on its behalf, assumes no responsibility or liability for any damages resulting from such improper use of sale. This publication supersedes & replaces all information previously supplied. For additional information, please visit our website <https://www.yfwdiode.com>, or consult YFW sales office for further assistance.