

Surface Mount Schottky Barrier Rectifier

Reverse Voltage - 40 to 200 V

Forward Current - 5 A

FEATURES

- ◆ High current capability
- ◆ Low forward voltage drop
- ◆ High surge capability
- ◆ High temperature soldering guaranteed
- ◆ Mounting position: any
- ◆ Lead free in comply with EU RoHS 2011/65/EU directives

MECHANICAL DATA

- ◆ Case: TO-252(D-PAK)
- ◆ Terminals: Solderable per MIL-STD-750, Method 2026
- ◆ Approx. Weight: 0.32g / 0.011oz

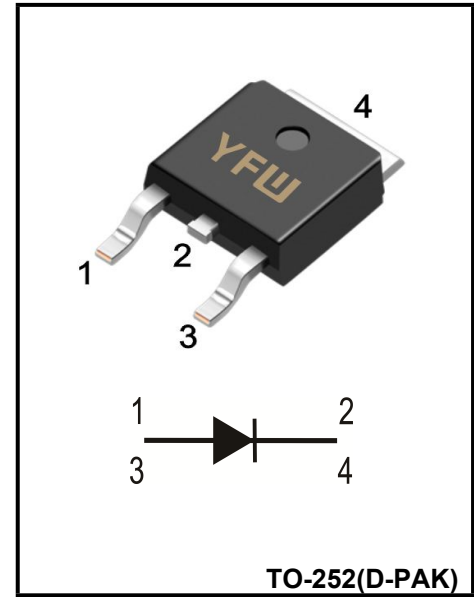

Maximum Ratings and Electrical characteristics
Ratings at 25 ° ambient temperature unless otherwise specified.

Parameter	Symbols	MBR540DS	MBR545DS	MBR560DS	MBR5100DS	MBR5150DS	MBR5200DS	Units	
Maximum Repetitive Peak Reverse Voltage	V_{RRM}	40	45	60	100	150	200	V	
Maximum RMS voltage	V_{RMS}	28	31.5	42	70	105	140	V	
Maximum DC Blocking Voltage	V_{DC}	40	45	60	100	150	200	V	
Maximum Average Forward Rectified Current	$I_{F(AV)}$	5.0						A	
Peak Forward Surge Current, 8.3ms Single Half Sine-wave Superimposed On Rated Load (JEDEC method)	I_{FSM}	120						A	
Maximum Instantaneous Forward Voltage at 5 A	V_F	0.65		0.70	0.85	0.90	0.92	v	
Maximum Instantaneous Reverse Current at Rated DC Reverse Voltage <small>$T_A = 25^{\circ}C$ $T_A = 100^{\circ}C$</small>	I_R	0.1 20			0.05 20			mA	
Typical Junction Capacitance ⁽¹⁾	C_j	600		400				pF	
Typical Thermal Resistance ⁽²⁾	$R_{\theta JA}$	35						°C/W	
Operating Junction Temperature Range	T_j	-55 ~ +150				-55 ~ +175			°C
Storage Temperature Range	T_{stg}	-55 ~ +150				-55 ~ +175			°C

(1) Measured at 1 MHz and applied reverse voltage of 4 V D.C

(2) P.C.B. mounted with 10cm X 10cmX1mm copper pad areas.

Fig.1 TYPICAL FORWARD CURRENT DERATING CURVE

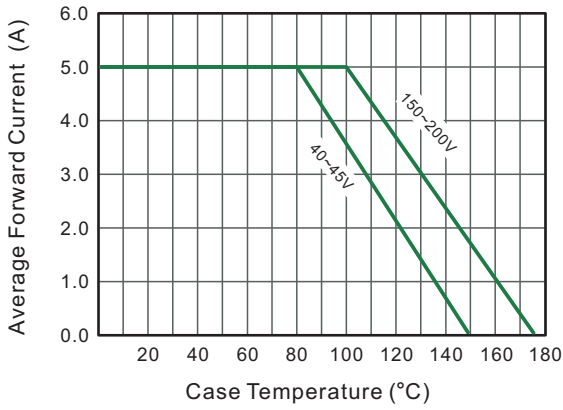

Fig.2 Typical Reverse Characteristics

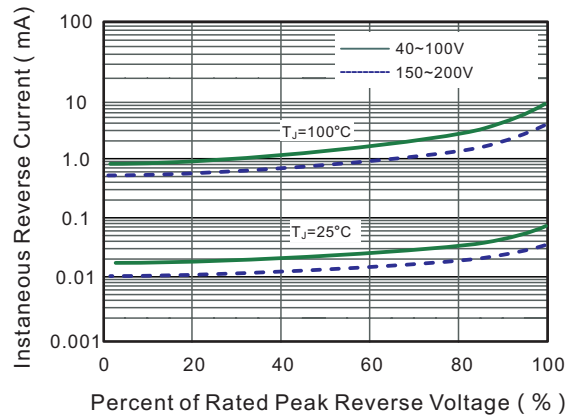

Fig.3 Typical Forward Characteristic

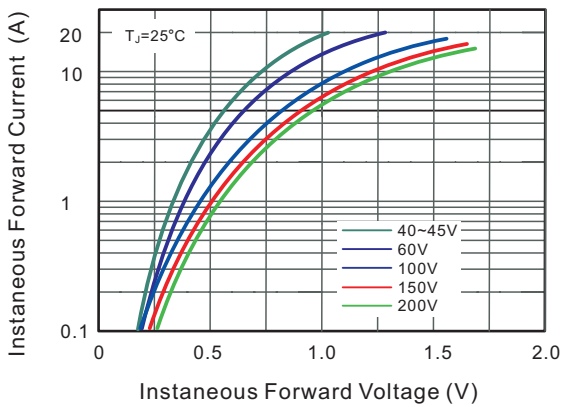

Fig.4 Typical Junction Capacitance

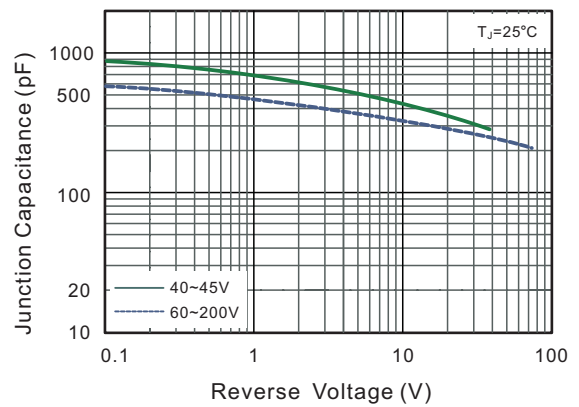

Fig.5 Maximum Non-Repetitive Peak Forward Surge Current

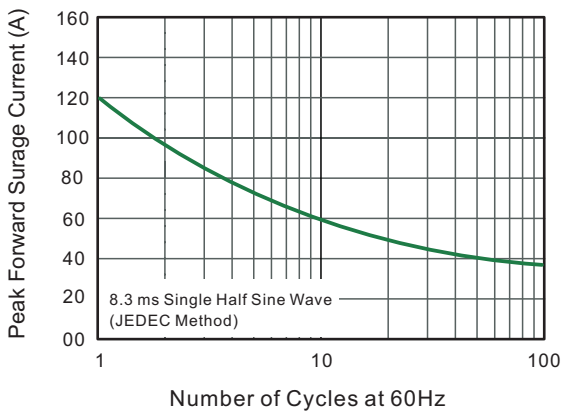
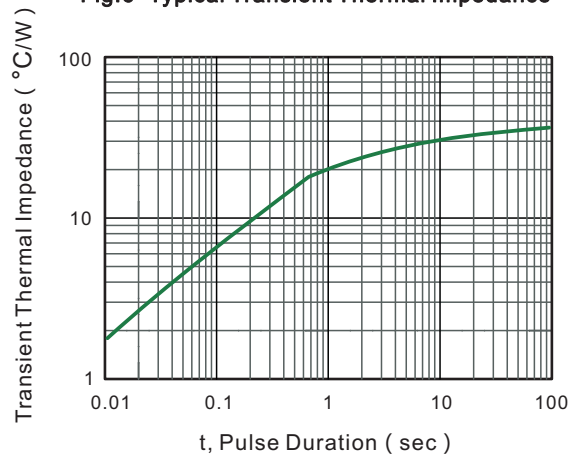
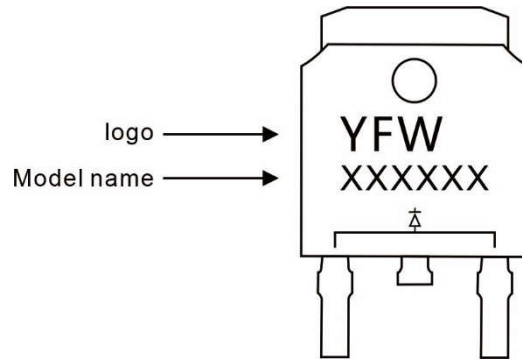

Fig.6- Typical Transient Thermal Impedance



Marking Diagram



Ordering information

Model name	Package	Unit Weight	Base Quantity	Packing Quantity
XXXXXX	TO-252	0.011oz(0.32g)	2500pcs/reel	5000pcs/box 25000pcs/Carton

Package Dimensions

TO-252

Dim	Millimeter		Inches	
	Min.	Max.	Min.	Max.
A	2.20	2.50	0.087	0.098
A1	0.00	0.12	0.000	0.005
A2	2.20	2.40	0.087	0.094
B	1.20	1.60	0.047	0.063
b	0.50	0.70	0.020	0.028
b1	0.70	0.90	0.028	0.035
c	0.40	0.60	0.016	0.024
c1	0.40	0.60	0.016	0.024
D	6.35	6.65	0.250	0.262
D1	5.20	5.40	0.205	0.213
E	5.40	5.70	0.213	0.224
e	2.20	2.40	0.087	0.094
e1	4.40	4.80	0.173	0.189
L	10.00	11.00	0.393	0.433
L1	2.70	3.10	0.106	0.122
L2	1.40	1.80	0.055	0.071
L3	0.90	1.50	0.035	0.059

Disclaimer

The information presented in this document is for reference only. GuangDong Youfeng Microelectronics Co.,Ltd. reserves the right to make changes without notice for the specification of the products displayed herein to improve reliability, function or design or otherwise. The product listed herein is designed to be used with ordinary electronic equipment or devices, and not designed to be used with equipment or devices which require high level of reliability and the malfunction of with would directly endanger human life (such as medical instruments, transportation equipment, aerospace machinery, nuclear-reactor controllers, fuel controllers and other safety devices),YFW or anyone on its behalf, assumes no responsibility or liability for any damages resulting from such improper use of sale. This publication supersedes & replaces all information previously supplied. For additional information, please visit our website <https://www.yfwdiode.com>, or consult YFW sales office for further assistance.