

Standard Surface Mounted Rectifiers

Reverse Voltage - 50 to 1000 V

Forward Current - 1.0 A

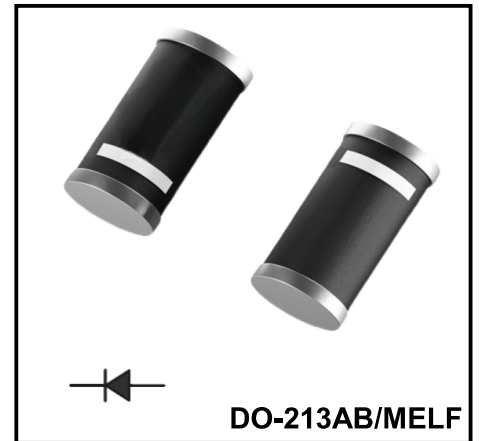

FEATURES

- ◆The plastic package carries Underwriters Laboratory Flammability Classification 94V-0
- ◆Idea for surface mounted application
- ◆Glass passivated junction chip
- ◆Low reverse leakage
- ◆High forward surge current capability
- ◆High temperature soldering guaranteed 260°C/10 seconds at terminals

MECHANICAL DATA

- ◆Case : Molded plastic body
- ◆Terminals : Solder plated, solderable per MIL-STD-750, Method 2026
- ◆Polarity : Polarity symbol marking on body
- ◆Mounting Position : Any
- ◆Weight : 0.0045 ounce, 0.1296 grams

Maximum Ratings And Electrical Characteristics

Ratings at 25°C ambient temperature unless otherwise specified. Single phase half-wave 60Hz, resistive or inductive load, for capacitive load current derate by 20%.

Parameter	Symbols	DL4001	DL4002	DL4003	DL4004	DL4005	DL4006	DL4007	Units
Maximum Repetitive Peak Reverse Voltage	V_{RRM}	50	100	200	400	600	800	1000	V
Maximum RMS voltage	V_{RMS}	35	70	140	280	420	560	700	V
Maximum DC Blocking Voltage	V_{DC}	50	100	200	400	600	800	1000	V
Maximum Average Forward Rectified Current at $T_L=100^\circ\text{C}$	$I_{(AV)}$	1.0							A
Peak Forward Surge Current, 8.3ms Single Half Sine-wave Superimposed On Rated Load	I_{FSM}	30							A
Maximum Instantaneous Forward Voltage at 1.0 A	V_F	1.0							V
Maximum DC reverse current at rated DC blocking voltage $T_A = 25^\circ\text{C}$ $T_A = 125^\circ\text{C}$	I_R	2 200							μA
Typical junction capacitance (Note1)	C_J	15							pF
Typical Thermal Resistance	$R_{\theta JA}$	75							$^\circ\text{C/W}$
Operating Junction Temperature Range	T_J	-55 ~ +150							$^\circ\text{C}$
Storage Temperature Range	T_{stg}	-55 ~ +150							$^\circ\text{C}$

Note:1.Measured at 1MHz and applied reverse voltage of 4.0V D.C.

Ratings And Characteristic Curves

FIG. 1- DERATING CURVE OUTPUT RECTIFIED CURRENT

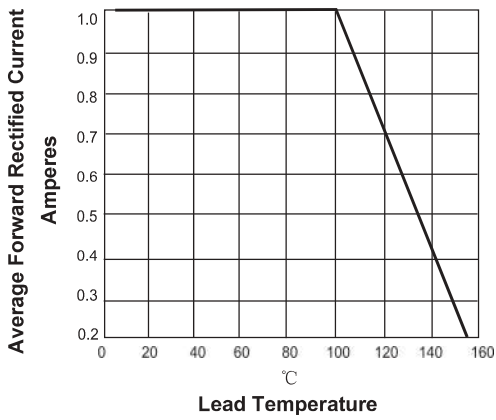

FIG. 2-MAXIMUM NON-REPETITIVE PEAK FORWARD SURGE CURRENT PER LEG

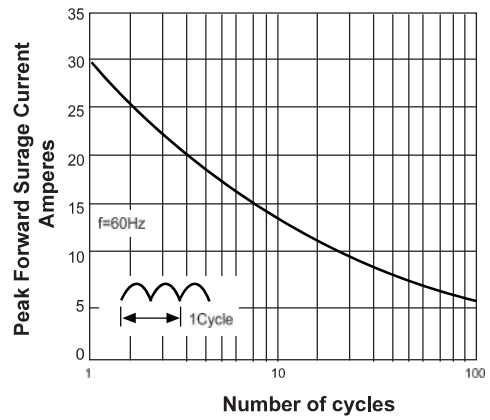

FIG. 3-TYPICAL FORWARD VOLTAGE CHARACTERISTICS

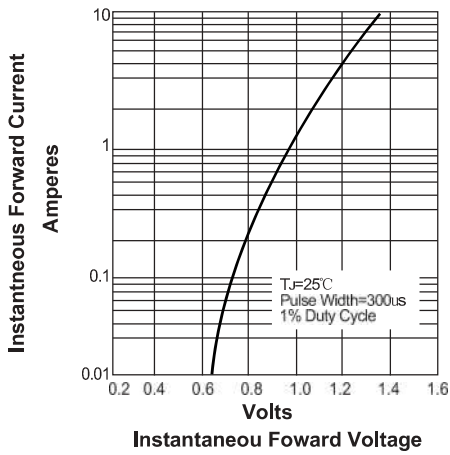
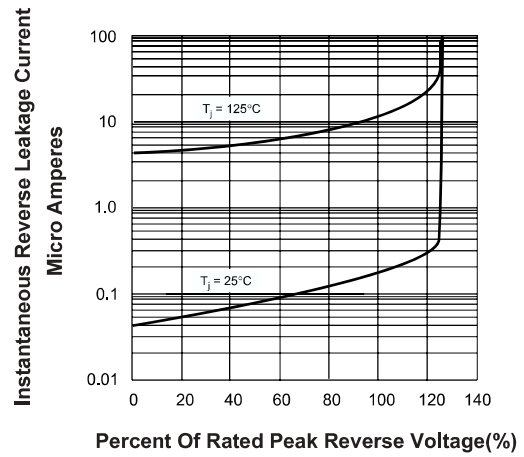

FIG. 4-TYPICAL REVERSE LEAKAGE CHARACTERISTICS



Ordering information

Package	Packing Description	Packing Quantity
DO-213AB(MELF)	Tape/Reel, 13"reel	5000PCS/Reel 50000PCS/Carton

Package Dimensions

DO-213AB(MELF)

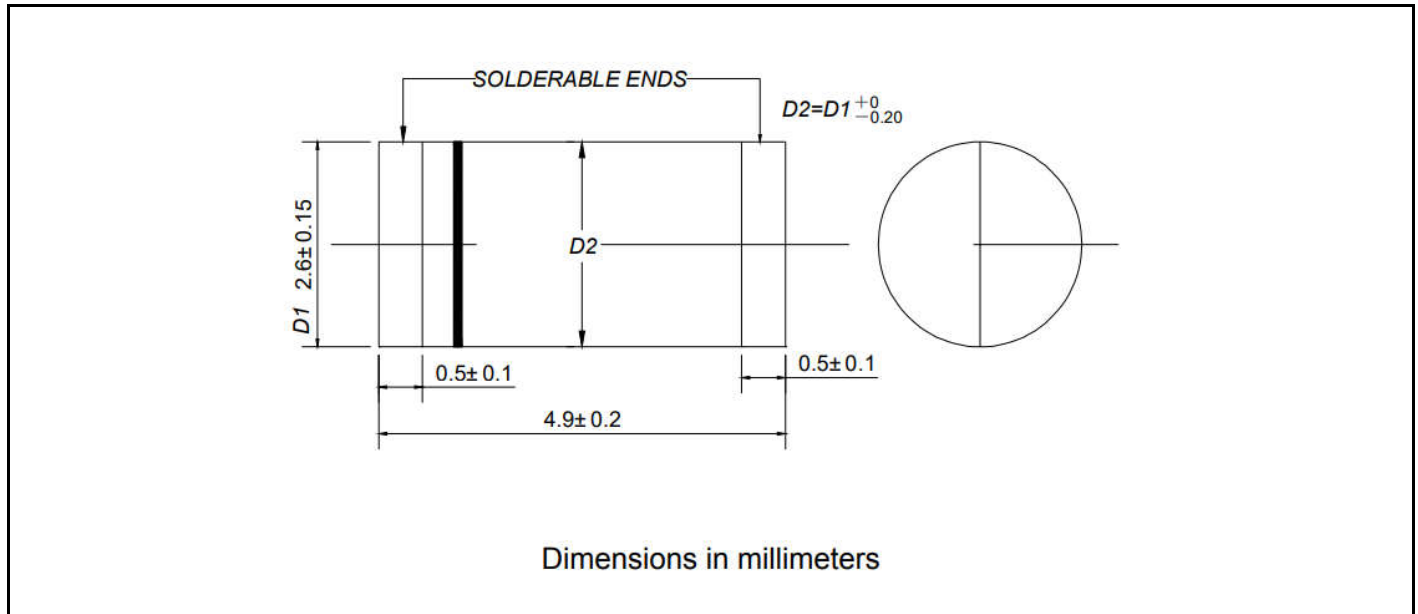

The recommended mounting pad size

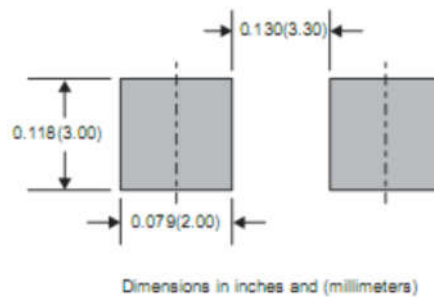

Disclaimer

The information presented in this document is for reference only. GuangDong Youfeng Microelectronics Co.,Ltd. reserves the right to make changes without notice for the specification of the products displayed herein to improve reliability, function or design or otherwise. The product listed herein is designed to be used with ordinary electronic equipment or devices, and not designed to be used with equipment or devices which require high level of reliability and the malfunction of with would directly endanger human life (such as medical instruments, transportation equipment, aerospace machinery, nuclear-reactor controllers, fuel controllers and other safety devices),YFW or anyone on its behalf, assumes no responsibility or liability for any damages resulting from such improper use of sale. This publication supersedes & replaces all information previously supplied. For additional information, please visit our website <https://www.yfwdiode.com>, or consult YFW sales office for further assistance.