

4.0A Super Fast Recovery Rectifier Bridge

Reverse Voltage - 300 to 600 V
Forward Current – 4.0A

FEATURES

- ◆High current capability
- ◆Low forward voltage drop
- ◆Glass Passivated Chip Junction
- ◆Low power loss, high efficiency
- ◆Lead free in comply with EU RoHS 2011/65/EU directives

MECHANICAL DATA

- ◆Case:D3K
- ◆Terminals: Solderable per MIL-STD-202E, Method 208C
- ◆Case:UL-94 Class V-0 recognized Flame Retardant Epoxy

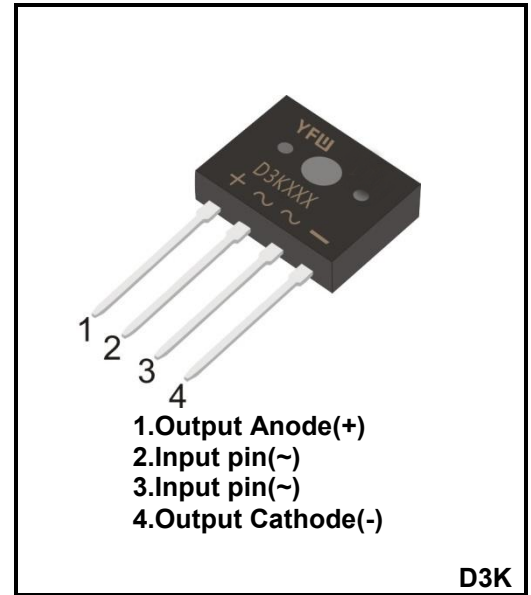

Maximum Ratings and Electrical characteristics

Ratings at 25 °C ambient temperature unless otherwise specified.

Parameter	Symbols	D3K403SF	D3K406SF	Units
Maximum Repetitive Peak Reverse Voltage	V_{RRM}	300	600	V
Maximum RMS voltage	V_{RMS}	200	420	V
Maximum DC Blocking Voltage	V_{DC}	300	600	V
Average Rectified Output Current	$I_{(AV)}$	4.0		A
Peak Forward Surge Current 8.3 ms Single Half Sine-Wave Superimposed on Rated Load (JEDEC method)	I_{FSM}	150		A
Forward Voltage per element @ $I_F=4A$ DC	V_F	0.95	1.45	V
Maximum Reverse Recovery Time	T_{rr}	35		nS
Maximum DC Reverse Current at Rated DC Blocking Voltage	@ $T_a=25^{\circ}C$	5		μA
	@ $T_a=125^{\circ}C$	500		
I^2t Rating for Fusing($3ms \leq t \leq 8.3ms$)	I^2t	26.5		A^2S
Typical Junction Capacitance	C_j	50		pF
Operating and Storage Temperature Range	T_j, T_{stg}	-55 ~ +175		$^{\circ}C$

(1) Measured at 1 MHz and applied reverse voltage of 4 V D.C

(2) Device mounted on 50mm*50mm*1.6mm cu plate heatsink

Ratings and Characteristic Curves

FIG.1-DERATING CURVE OUTPUT RECTIFIED CURRENT

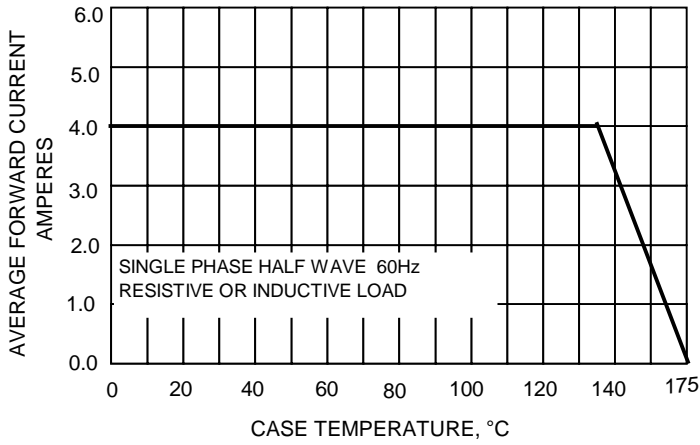

FIG.2-MAXIMUM NON-REPETITIVE SURGE CURRENT

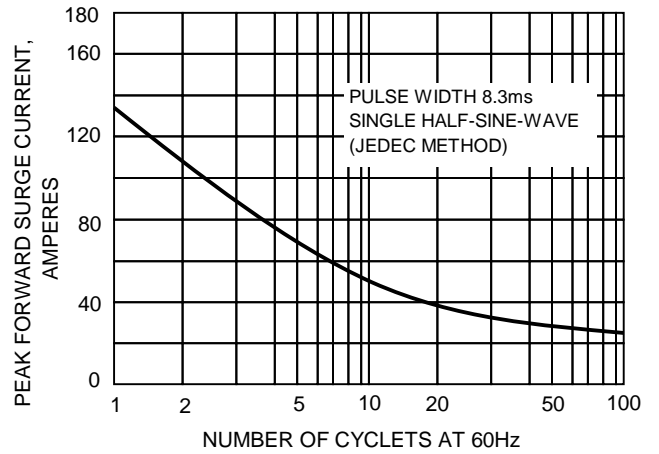

FIG.3-TYPICAL JUNCTION CAPACITANCE

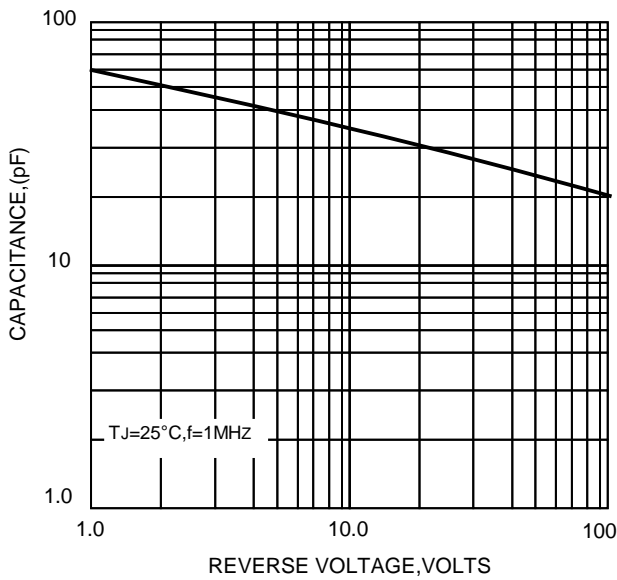

FIG.3-TYPICAL FORWARD CHARACTERISTICS

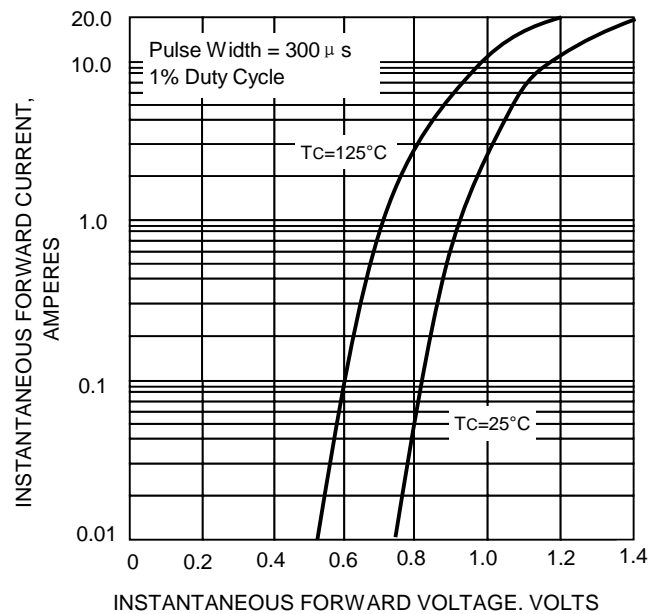
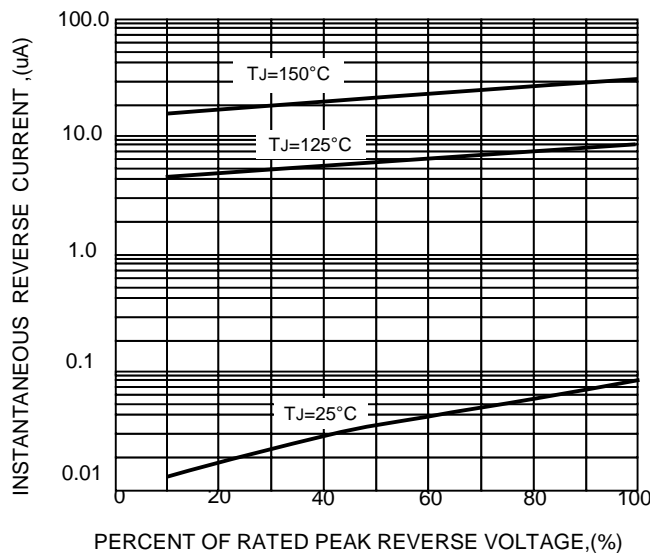
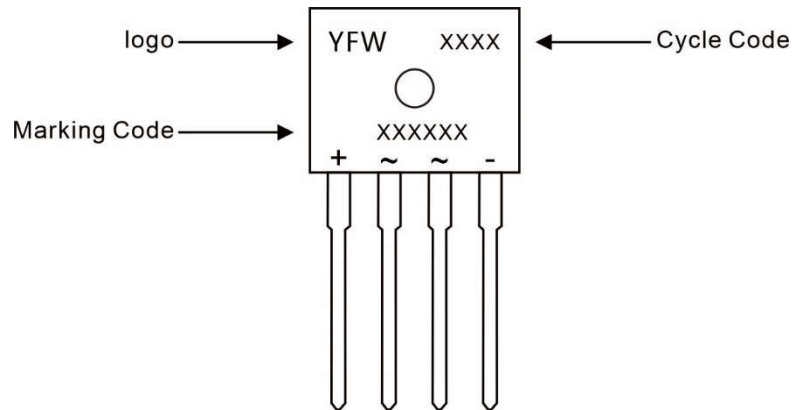

FIG.5-TYPICAL REVERSE CHARACTERISTICS



Marking Diagram



Ordering information

Package	Packing Description	Packing Quantity
D3K	bulk	500PCS/Box 5000PCS/Carton

Package Dimensions

D3K

Dim.	Millimeter(mm)		Dimensions inInch	
	Min.	Max.	Min.	Max.
A	13.5	14.5	0.53	0.57
B	10.0	11.0	0.39	0.43
C	1.8	2.4	0.07	0.09
D	12.8	14.8	0.50	0.58
E	3.76	3.86	0.15	0.15
F	0.65	0.85	0.03	0.03
G	1.2	1.4	0.05	0.06
H	5.0	5.5	0.20	0.22
I	3.05	3.45	0.12	0.14
J	3.1	3.6	0.12	0.14

Disclaimer

The information presented in this document is for reference only. Guangdong Youfeng Microelectronics Co.,Ltd. reserves the right to make changes without notice for the specification of the products displayed herein to improve reliability, function or design or otherwise. The product listed herein is designed to be used with ordinary electronic equipment or devices, and not designed to be used with equipment or devices which require high level of reliability and the malfunction of which would directly endanger human life (such as medical instruments, transportation equipment, aerospace machinery, nuclear-reactor controllers, fuel controllers and other safety devices), YFW or anyone on its behalf, assumes no responsibility or liability for any damages resulting from such improper use of sale. This publication supersedes & replaces all information previously supplied. For additional information, please visit our website <https://www.yfwdiode.com>, or consult YFW sales office for further assistance.