

## Surface Mount Superfast Recovery Rectifier

Reverse Voltage - 50 to 600 V

Forward Current - 1 A

### FEATURES

- ◆ Glass Passivated Chip Junction
- ◆ For surface mounted applications
- ◆ Low profile package
- ◆ Superfast reverse recovery time
- ◆ Lead free in comply with EU RoHS 2011/65/EU directives

### MECHANICAL DATA

- ◆ Case: SMAF
- ◆ Terminals: Solderable per MIL-STD-750, Method 2026
- ◆ Approx. Weight: 27mg / 0.00095oz

### Pinning

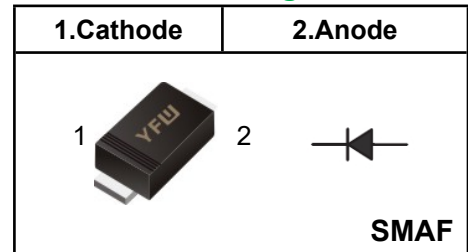

### Marking Code

<b>ES1AF</b>	<b>YFW ES1A</b>
<b>ES1BF</b>	<b>YFW ES1B</b>
<b>ES1DF</b>	<b>YFW ES1D</b>
<b>ES1GF</b>	<b>YFW ES1G</b>
<b>ES1JF</b>	<b>YFW ES1J</b>

### Absolute Maximum Ratings and characteristics

Ratings at 25 °C ambient temperature unless otherwise specified.

Single phase half-wave 60 Hz, resistive or inductive load, for capacitive load current derate by 20 %.

Parameter	Symbols	ES1AF	ES1BF	ES1DF	ES1GF	ES1JF	Units
Maximum Repetitive Peak Reverse Voltage	$V_{RRM}$	50	100	200	400	600	V
Maximum RMS voltage	$V_{RMS}$	35	70	140	280	420	V
Maximum DC Blocking Voltage	$V_{DC}$	50	100	200	400	600	V
Maximum Average Forward Rectified Current at $T_c = 125\text{ }^\circ\text{C}$	$I_{F(AV)}$	1					A
Peak Forward Surge Current 8.3 ms Single Half Sine Wave Superimposed on Rated Load	$I_{FSM}$	30					A
Maximum Instantaneous Forward Voltage at 1 A	$V_F$	0.95			1.25	1.65	V
Maximum DC Reverse Current $T_a = 25\text{ }^\circ\text{C}$ at Rated DC Blocking Voltage $T_a = 125\text{ }^\circ\text{C}$	$I_R$	5 100					$\mu\text{A}$
Typical Junction Capacitance at $V_R = 4\text{V}, f = 1\text{MHz}$	$C_j$	15					pF
Maximum Reverse Recovery Time <sup>(1)</sup>	$T_{rr}$	35					nS
Typical Thermal Resistance <sup>(2)</sup>	$R_{\theta JA}$	80					$^\circ\text{C/W}$
Operating and Storage Temperature Range	$T_j, T_{stg}$	-55 ~ +150					$^\circ\text{C}$

(1) Measured with  $I_F = 0.5\text{A}, I_R = 1\text{A}, I_n = 0.25\text{A}$

(2) P.C.B. mounted with 2.0" X 2.0" (5 X 5 cm) copper pad areas.

**Fig.1 Reverse Recovery Time Characteristic And Test Circuit Diagram**

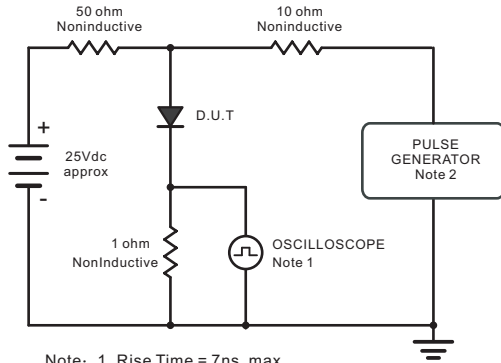

Note: 1. Rise Time = 7ns, max.  
Input Impedance = 1megohm, 22pF.  
2. Rise Time = 10ns, max.  
Source Impedance = 50 ohms.

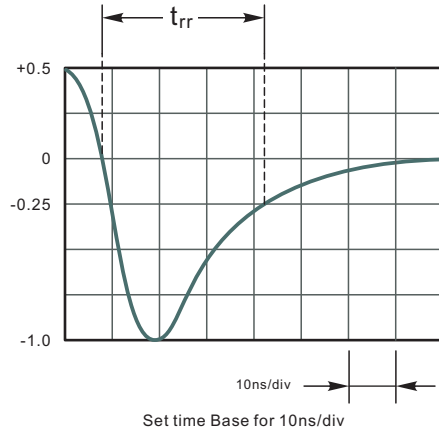

**Fig.2 Maximum Average Forward Current Rating**

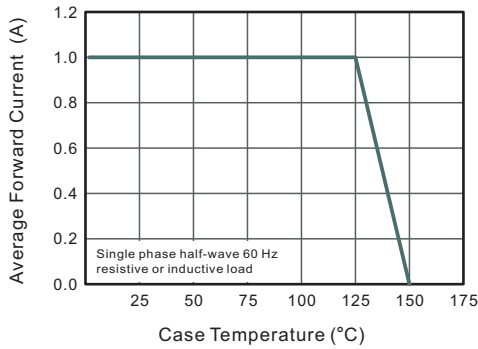

**Fig.3 Typical Reverse Characteristics**

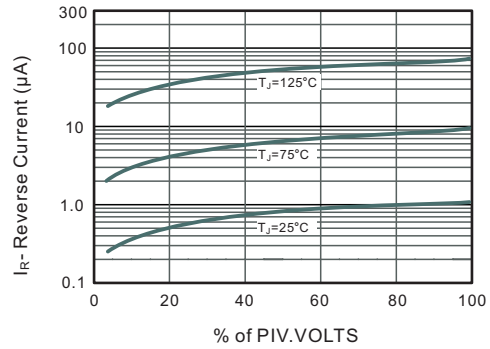

**Fig.4 Typical Forward Characteristics**

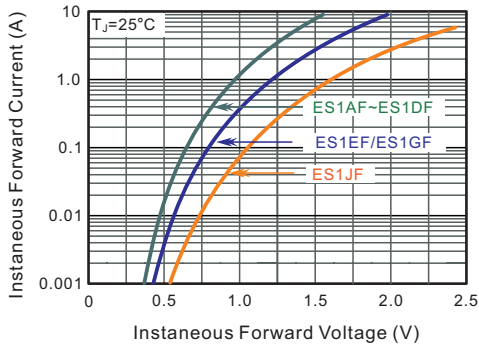

**Fig.5 Typical Junction Capacitance**

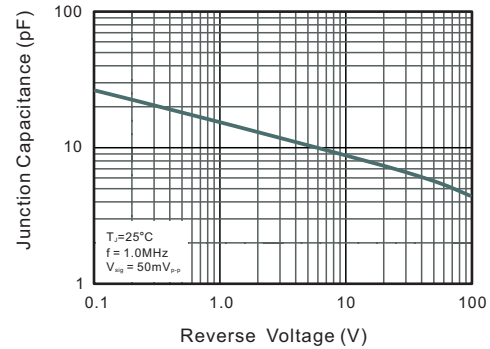

**Fig.6 Maximum Non-Repetitive Peak Forward Surge Current**

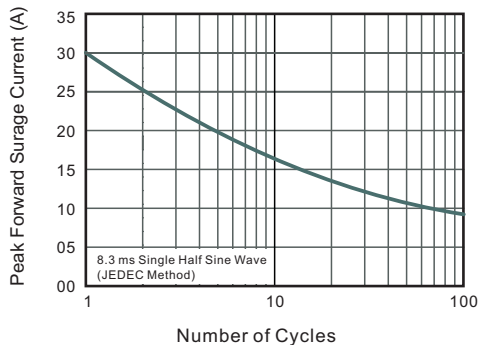

**Marking Diagram**



**Ordering information**

Package	Packing Description	Packing Quantity
SMAF	Tape/Reel, 7" reel	3000PCS/Reel 9000PCS/Carton

**Package Dimensions**

**SMAF**

Dim.	Millimeter(mm)		mil	
	Min.	Max.	Min.	Max.
A	0.9	1.1	35	43
C	0.12	0.20	4.7	7.9
D	3.3	3.7	130	146
E	2.4	2.7	94	106
e	1.3	1.6	51	63
g	0.8	1.2	31	47
HE	4.4	4.9	173	193
∠	7°			

**The recommended mounting pad size**

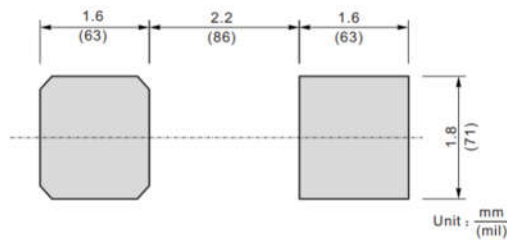

## Disclaimer

The information presented in this document is for reference only. GuangDong Youfeng Microelectronics Co.,Ltd. reserves the right to make changes without notice for the specification of the products displayed herein to improve reliability, function or design or otherwise. The product listed herein is designed to be used with ordinary electronic equipment or devices, and not designed to be used with equipment or devices which require high level of reliability and the malfunction of with would directly endanger human life (such as medical instruments, transportation equipment, aerospace machinery, nuclear-reactor controllers, fuel controllers and other safety devices),YFW or anyone on its behalf, assumes no responsibility or liability for any damages resulting from such improper use of sale. This publication supersedes & replaces all information previously supplied. For additional information, please visit our website <https://www.yfwdiode.com>, or consult YFW sales office for further assistance.